

REEDY POWER 1416C2L LITHIUM

DUAL AC/DC COMPETITION BATTERY CHARGER



Part # 27203

INSTRUCTION MANUAL

WWW.REEDYPOWER.COM

Table of Contents

Introduction	3
Specifications.....	3
Special Features.....	4
Warning and Safety Notes.....	5
Powering Your Charger	6
Program Flow Chart	7
System Setup.....	8-9
Connecting Your Battery	10
Lithium Battery Program	11-15
Lithium Balance Charging.....	11-12
Lithium Fast Charging.....	13
Storage Control	14
Lithium Discharging.....	15
Igniter Mode	16
Additional Displayed Information	17
Memory Settings	18-19
Lithium Battery Meter.....	20
Resistance Meter	20
DC Power Supply.....	21
Warning and Error Messages	22
Warranty	22
Regulatory Information.....	23

Introduction

Congratulations on your purchase of Reedy's 1416-C2L Dual AC/DC Competition Lithium Battery Charger. The latest electronics technology along with the design and engineering experience that is responsible for 30 World Championship titles has been incorporated into its design.

A high-performance microprocessor, specialized operating software, and many advanced features make it the perfect charging solution for new hobbyists, casual enthusiasts, or hardcore racers.

Simultaneous charging of two batteries at up to 14A is possible thank to a powerful integrated power supply. Storage of up to 10 (per channel) different charge profiles allows for easy access to your most commonly used settings. End Voltage Control (EV) gives racers and added option to regulate power output and calibrate voltage while 1S Balance Mode results in accurate voltage readings when charging 1S batteries.

Safety has not been overlooked with the 1416-C2L thanks to its lithium specific charging scheme that requires balance charging in modes appropriate for lithium batteries. Nitro racers haven't been overlooked thanks to a specific mode designed for single cell NiMH igniter batteries.

In addition to its long list of powerful features, the 1416-C2L features an attractive exterior with a compact footprint and front facing outputs to maximize pit space.

Please read the following instructions before operating your charger for the first time.

SPECIFICATIONS

Input Voltage	AC100-240V, DC 11-18V
Charge/Discharge Power	Max 130W/10W (x2)
Charge/Discharge Current	0.1-14.0A/0.1-2.0A
LiPo/LiPo-HV/LiFe/LiLo Cell Count	1-6 series
Power Supply Output	5-25V, 2 x 130W
Igniter Mode	1-cell NiMH
Dimensions	160 x 150 x 71mm
Weight	896g/31.6oz

Your charger's maximum charge output is 130W per channel (not to exceed 14A) and 10W per channel for discharge. This means that the maximum charge and discharge rates differ depending on the number of cells being processed. You can estimate the maximum charge and discharge rate for your battery by dividing 130 (charge) or 10 (discharge) by the Max Charge Voltage of the battery. See the chart on page 11 to view estimates for lithium batteries.

CAUTION! This calculation and the chart on page 11 depict the maximum capabilities of your charger. ALWAYS consult with instruction manual included with your battery for charging and discharging instructions.

Special Features

- *130W x2 Digital AC/DC Balance Charger*
- *1-6S LiPo, Li-HV, Lilo, LiFe Compatible*
- *Maximum 14A Charge/2A Discharge*
- *10 Profile Charger Memory*
- *DC Power Supply Function*
- *End Voltage Control (EV)*
- *Igniter Mode*
- *1S Balance Mode*
- *Backlit LCD Screen*
- *Heavy-Duty Cooling Fan*
- *5V/2.1A USB Charge/Accessory Port*
- *Power Switch*
- *Firmware Updateable*

Charging Versatility

The 1416-C2L is a one-stop battery charging solution for electric and nitro racers. It is capable of charging 1-6S LiPo, LiPo-HV (LiHV), LiFe, and Lilo batteries as well and single cell NiMH igniters.

Power Supply Function

Use one or both channels to power items such as pit lights, tire sanders, and battery warmers.

Battery Resistance Meter

Determine the internal resistance of individual cells and the entire battery.

10-Profile Memory

Save and recall up to 10 (per channel) different charge/discharge profiles for your convenience.

End Voltage Control

Adjust the charge end voltage between 4.00V and 4.40V per cell. Modified races can take advantage of a lower voltage battery while stock racers have the opportunity to fine tune their charge voltage to the maximum value allowed by race organizers.

Lithium Battery Meter

View total voltage, individual cell voltages, and highest/lowest cell voltages to determine the battery's condition and state of charge.

Fast and Storage Modes

Alternate lithium charge modes add versatility to the charging process. Fast Charge mode reduces charge times by shortening the secondary charge process while Storage mode ensures that the battery's state of charge is at a level suitable for long-term storage.

Charge Time and Capacity Limits

To prevent overcharging due to a malfunctioning battery, the charging process will automatically stop if the charge time and/or the capacity limit exceeds the value determined by the user.

Warning and Safety Notes

- **NEVER** leave the charger unsupervised during use. If any malfunction is observed, immediately terminate the charging process.
- **ALWAYS** observe warnings and cautions included with your battery.
- **ALWAYS** refer to the instructions included with your battery when determining the proper charge, discharge, and storage parameters.
- **NEVER** charge a battery that is swollen, appears damaged in any way, consists of different types of cells (including different manufacturers), non-rechargeable batteries, batteries with an integral charger circuit or protection circuit, batteries installed in a vehicle/device or electrically linked to other components, or batteries that are not expressly stated by the manufacturer to be compatible with the charge current that this charger delivers during the charging process.
- **NEVER** charge any battery other than LiPo, LiHV, LiFe, Lilo or 1S Igniter Batteries.
- **ALWAYS** place the battery and charger on a heat-resistant, non-flammable, and non-conductive surface away from flammable and volatile materials.
- **ALWAYS** place the battery in a fireproof container during the charging process.
- **ALWAYS** double-check all connections prior to starting the charging process.
- **ALWAYS** connect the charge lead to the charger first, then connect the battery to the charge lead.
- **NEVER** remove the charge lead from the charger while a battery is plugged into the charge lead.
- **ALWAYS** remove the battery from the charger and unplug the charger from the wall when not in use.
- **NEVER** leave the battery plugged into the charger when the charger is unplugged from the wall.
- **ALWAYS** keep the charger away from moisture, dust, heat, direct sunlight and vibration. Do not drop it.
- **ALWAYS** power off and/or unplug the charger when not in use.

CAUTION! This product is a sophisticated hobby product and not a toy. It must be operated with caution and common sense. Failure to operate this product in a safe and responsible manner could result in injury or damage to the product or property. This product is not intended to be used by children without direct adult supervision. It is essential to read and follow all instructions and warnings found in this manual prior to installation, set up, and use, for the product to operate properly and to avoid damage or injury.

STANDARD BATTERY PARAMETERS

	LiPo	LiPo-HV (LiHV)	Lilo	LiFe	NiMH Igniter
Nominal Voltage	3.7V/cell	3.8V/cell	3.6V/cell	3.3V/cell	1.2V/cell
Max. Charge Voltage	4.2V/cell	4.35V/cell	4.1V/cell	3.6V/cell	1.5V/cell
Storage Voltage	3.8V/cell	3.9V/cell	3.7V/cell	3.3V/cell	N/A
Allowable Fast Charge	≤ 1C	≤ 1C	≤ 1C	≤ 1C	1C-2C
Min. Discharge Voltage	3.2V/cell	3.2V/cell	3.2V/cell	2.9V/cell	0.9V/cell

CAUTION! Failure to select the appropriate settings for the battery you are charging may result in damage to the battery, fire, or explosion.

Powering Your Charger

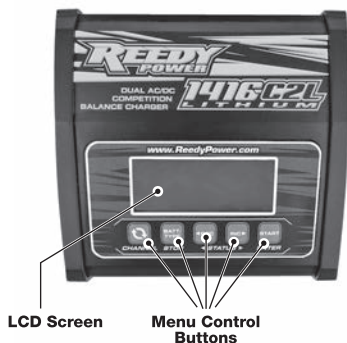

LCD Screen

Menu Control Buttons

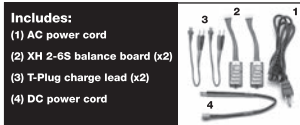

Includes:

- (1) AC power cord
- (2) XH 2-6S balance board (x2)
- (3) T-Plug charge lead (x2)
- (4) DC power cord

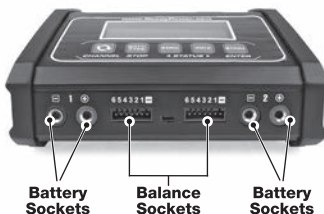

Battery Sockets

Balance Sockets

Battery Sockets



USB Output
5V, 2.1A

DC Input
11-18V DC

Cooling fan



On/Off
Power Switch

AC Input
100-240V AC

If you are plugging your charger into AC power, your charger will automatically detect input voltage between 100V and 240V. Place the charger on a non-flammable surface and then plug the AC power cord provided into a suitable wall socket and switch the charger on. A US to IEC 320 C5 cord is included. Cords for other regions must be purchased separately.

If you plan to use DC power, connect the charger to a 12V power supply using the DC power cord supplied with the charger. The charger will automatically power on regardless of the power switch position.

Program Flow Chart

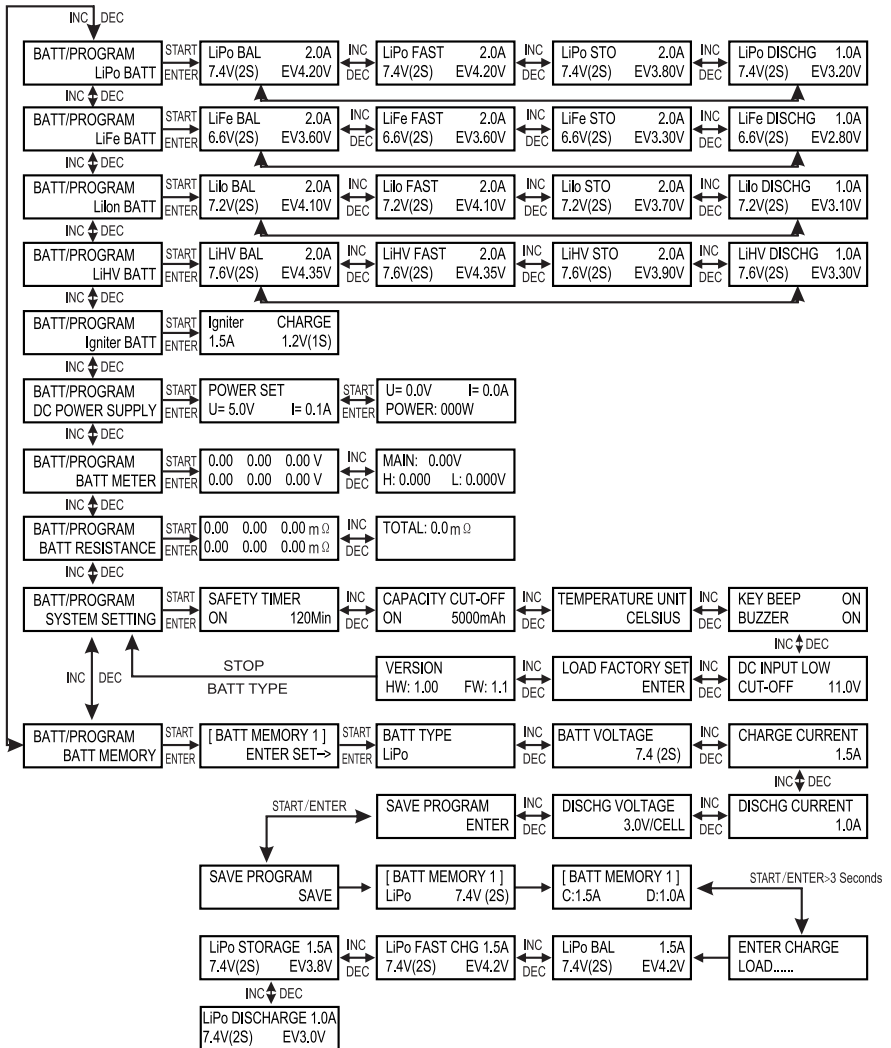

System Setup

System Settings

Your charger comes with pre-programmed system settings that can be modified to suit your particular requirements. Select System Setting to display the following information in sequence using the INC and DEC buttons. To change a value select it by pressing ENTER. The blinking value can be changed by using the INC and DEC buttons. Once you have chosen the desired value, press ENTER to save it. When you have finished making the desired changes, press STOP to return to the BATT/PROGRAM menu.

BATT/PROGRAM
SYSTEM SETTING

System Settings start screen.

BATT. TYPE
STOP

START
ENTER

SAFETY TIMER
OFF 120MIN

When the charging process begins, the Safety Timer automatically starts. In the case of a faulty battery or charger malfunction, the Safety Timer will automatically stop the charging process. This value should be set so that the battery reaches full capacity before the Safety Timer activates.

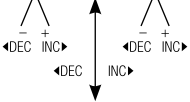

CAPACITY CUT-OFF
ON 1000mAh

Capacity Cut-Off also operates as a safety timer. If the programmed charge capacity is reached before the normal charging process has completed, the charger will terminate the charging process. A value of 500mAh over the capacity of the typical battery being charged is sufficient. Even though the Capacity Cut-Off can be disabled, it is not recommended.



TEMPERATURE UNIT
FAHRENHEIT

Display either Fahrenheit or Celsius when applicable.

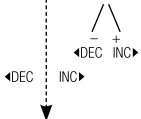

**CONTINUE TO
PAGE 9**

System Setup *(continued)*

**CONTINUED FROM
PAGE 8**

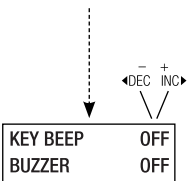

If you prefer to turn the charger's key beep and notification/alert sounds on or off, you can do so by selecting the appropriate setting.

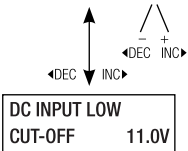

The charger continuously monitors the charger's input voltage. If the voltage drops below the programmed value, the charger will terminate the current process to protect the input source.

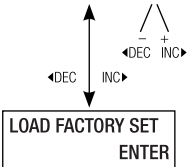

By pressing Enter, the charger's factory default settings will be re-loaded.

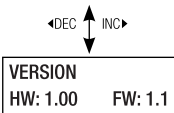

The installed hardware and software versions are displayed on this screen.

Connecting Your Battery

After powering your charger, you are ready to connect your battery to the charger so that the charging process can begin. The following applies to each charger bank, labeled 1 and 2.

1. Verify that the charger has been plugged into a suitable wall socket or 12V power supply.
2. If using AC power, turn the charger on using the power switch. When using DC power, the charger automatically powers on when connected to the power supply.
3. Connect the charge lead to the charger, making sure that the polarity is correct; red/+ is positive and black/- is negative.
4. Connect the balance board to the charger by plugging it into the balance socket (required for charging lithium batteries).
5. Plug the battery main lead into the charge lead.
6. Plug the battery balance lead into the appropriate balance board socket (required for balance charging lithium batteries).
7. Start the charging process (see specific instructions for your battery type in the next section of this manual).
8. When the charging process is completed, disconnect the battery balance lead from the balance board and the battery main lead from the charge lead.

Note: Should the batteries you wish to charge require a different charge lead or balance board, please consult your local hobby dealer or www.reedypower.com for a list of optional accessories.

CAUTION! In order for your charger to detect incorrect connections and display a warning, it must be powered before connecting a battery. Failure to do so may result in permanent damage to the charger. Never remove power from the charger when a battery is connected. If you encounter a "REVERSE POLARITY" warning, disconnect the battery immediately!

CAUTION! To avoid short circuiting a battery, first connect the charge leads to the charger. Once connected, plug the battery into the charge leads. Always unplug the battery from the charge leads. Never remove the charge leads from the charger when a battery is connected to them.

Lithium Battery Program (LiPo/LiHV/LiFe/LiIo)

The 1416-C2L is designed specifically for lithium batteries with a nominal voltage of 3.7V (LiPo), 3.8V (LiHV), 3.3V (LiFe), and 3.6V (LiIo) per cell. In addition to the option of selecting the appropriate battery type, you can select the charge rate, number of cells, and end voltage.

To determine the correct charge rate and cell count, refer to the instruction manual included with your battery. If you are unable to determine the charge rate or cell count, contact the battery manufacturer for guidance before continuing.

End Voltage Control (EV) allows you to adjust the end charge voltage to between 4.00V and 4.25V per cell for LiPo batteries and between 4.25V and 4.40V for LiHV batteries. This feature can be used to fine tune the end voltage so that it complies with local racing regulations or to reduce vehicle power as a tuning option. EV is only available in LiPo and LiHV Balance and Fast Charge modes.

Your charger operates using a CC/CV (Constant Current/Constant Voltage) charging scheme. When the battery reaches its predetermined voltage, the charge current will drop until the battery has reached maximum capacity.

MAX CHARGE RATES

1S		2S		3S		4S		5S		6S	
Charge	Disch.	Charge	Disch.	Charge	Disch.	Charge	Disch.	Charge	Disch.	Charge	Disch.
14.0A	2.0A	14A	1.2A	10.0A	0.8A	7.5A	0.7A	6.0A	0.5A	5.0A	0.6A

Rates may vary slightly based on connection quality and manufacturing tolerances. If the charge rate is set above the maximum allowed, the charger will automatically reduce the current to the maximum level.

Lithium Balance Charging

For maximum safety, performance, and cycle-life, your 1416-C2L is designed to only allow balance charging of lithium batteries. With Balance Charging, the charger monitors the voltage of each individual cell and adjusts the charge current automatically so that each cell within the battery is charged equally. The balance board must be connected to the charger and the battery's balance lead plugged into the balance board for the charger to operate.

Your 1416-C2L also includes the ability to charge 1S batteries in balance mode. With an appropriate 1S balance charge lead, you can connect your 1S battery to your charger using the balance board. This method will allow the charger to read the battery's voltage accurately resulting a better-quality charge and reduced charge times.

Lithium Battery Program (LiPo/LiHV/LiFe/LiIo)

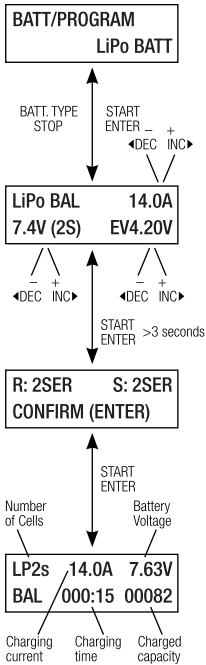

From the LiPo BAL screen, select the charge rate, voltage/cells, and end voltage (EV) value for the battery that you wish to charge. Press START/ENTER to select the value that you want to change and DEC/INC to change the value. Once you are satisfied with the selections, press and hold START/ENTER for more than three seconds to begin the Balance Charging process.

Verify that the number of cells selected matches the number of cells detected by the charger. R=number of cells detected by the charger, S=number of cells selected by the user. If the numbers match, confirm by pressing START/ENTER. If not, or you would like to make changes, press BATT TYPE/STOP to return to the previous screen.

Once the Balance Charging process has started, you will be able to view the real-time status of the battery being charged. Additional information can be viewed using the STATUS buttons (See page #17). If at any time you wish to terminate the Balance Charging process, press BATT TYPE/STOP.

Lithium Battery Program (LiPo/LiHV/LiFe/LiIo)

Lithium Fast Charging

Fast Charging will shorten the CV (Constant Voltage) portion of the charging process. However, the capacity of the battery will be reduced slightly resulting in reduced run times. Unless you are participating in organized competition, in a class that is run time sensitive, fast charging is an excellent alternative that gets you back on track quickly.

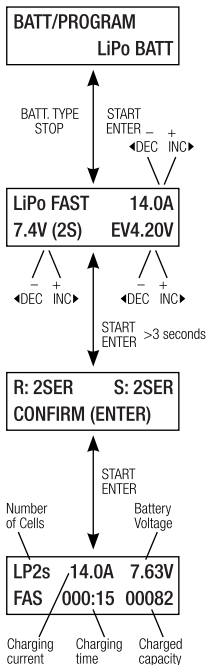

From the LiPo FAST screen, select the charge rate, voltage/cells, and end voltage (EV) value for the battery that you wish to charge. Press START/ENTER to select the value that you want to change and DEC/INC to change the value. Once you are satisfied with the selections, press and hold START/ENTER for more than three seconds to begin the Fast Charging process.

Verify that the number of cells selected matches the number of cells detected by the charger. R=number of cells detected by the charger, S=number of cells selected by the user. If the numbers match, confirm by pressing START/ENTER. If not, or you would like to make changes, press BATT TYPE/STOP to return to the previous screen.

Once the Fast Charging process has started, you will be able to view the real-time status of the battery being charged. Additional information can be viewed using the STATUS buttons (see page #17). If at any time you wish to terminate the Balance Charging process, press BATT TYPE/STOP.

Lithium Battery Program (LiPo/LiHV/LiFe/LiIo)

Storage Control

Lithium batteries perform best and experience longer life when they are stored at the optimum state of charge. Storage Control determines whether to charge or discharge your battery so that it can be stored at the optimum level when not in use.

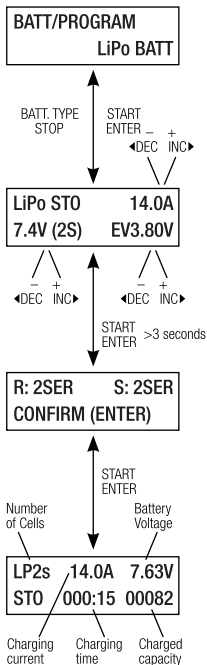

From the LiPo STO screen, select the charge rate and voltage/cells for the battery that you wish to store. Press START/ENTER to select the value that you want to change and DEC/INC to change the value. Once you are satisfied with the selections, press and hold START/ENTER for more than three seconds to begin the Storage Control process.

Verify that the number of cells selected matches the number of cells detected by the charger. R=number of cells detected by the charger, S=number of cells selected by the user. If the numbers match, confirm by pressing START/ENTER. If not, or you would like to make changes, press BATT TYPE/STOP to return to the previous screen.

Once the Storage Control process has started, you will be able to view the real-time status of the battery being charged. Additional information can be viewed using the STATUS buttons (see page #17). If at any time you wish to terminate the Storage Control process, press BATT TYPE/STOP.

NOTE: The discharge rate utilized by Storage Control can be set by following the instructions in the Lithium Discharging section of this manual.

Lithium Battery Program (LiPo/LiHV/LiFe/LiIo)

Lithium Discharging

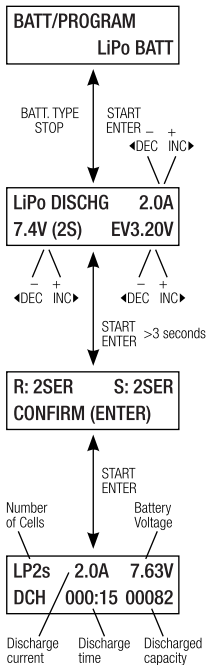

From the LiPo DISCHG screen, select the discharge rate, voltage/cells, and end voltage (EV) value for the battery that you wish to discharge. Press START/ENTER to select the value that you want to change and DEC/INC to change the value. Once you are satisfied with the selections, press and hold START/ENTER for more than three seconds to begin the Discharging process.

Verify that the number of cells selected matches the number of cells detected by the charger. R=number of cells detected by the charger, S=number of cells selected by the user. If the numbers match, confirm by pressing START/ENTER. If not, or you would like to make changes, press BATT TYPE/STOP to return to the previous screen.

Once the Discharging process has started, you will be able to view the real-time status of the battery being discharged. Additional information can be viewed using the STATUS buttons (See page #17). If at any time you wish to terminate the Discharging process, press BATT TYPE/STOP

CAUTION! Never discharge a lithium battery below the minimum manufacturer's recommended voltage and never store the battery at the minimum voltage. In both cases, the battery may eventually malfunction resulting in permanent battery damage or fire.

Igniter Mode

Igniter Mode

Although your 1416-C2L is designed for balance charging lithium-based batteries, Igniter Mode allows users to charge 1-cell NiMH igniter batteries if the appropriate charge lead is used. Your 1416-C2L uses delta peak detection charge circuitry to terminate the charging process when the battery has reached maximum capacity

Igniter Charging

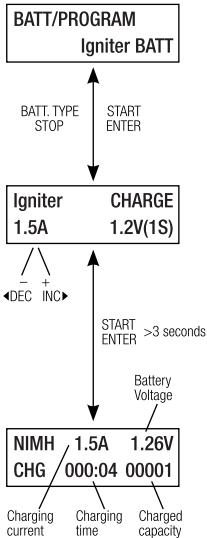

From the Igniter CHARGE screen, select the charge rate suitable for the igniter battery you are charging. Press START/ENTER to select the current and DEC/INC to change the value. Once you are satisfied with the selection, press and hold START/ENTER for more than three seconds to begin the charging process.

Once the Igniter CHARGE process has started, you will be able to view the real-time status of the battery being charged. If at any time you wish to terminate the Igniter CHARGE process, press BATT TYPE/STOP.

Additional Displayed Information

When charging, you can view additional on-screen information during charging or discharging process. Pressing the DEC and INC button will allow you to scroll through your user settings and information relating directly to the battery being charged/discharged. To return to the charge information menu, press START/ENTER.

[INC]

4.19	4.19	0.00 V
0.00	0.00	0.00 V

Individual cell voltage readings



Capacity = 99%
Cell = 4.19V

Current charge percentage and average cell voltage.

[DEC]

End Voltage
8.40V(2S)

Charge end voltage



IN Power Voltage
15.9V

Current input voltage



INT. TEMP:	98F
------------	-----

Internal charger temperature



SAFETY TIMER	
OFF	120Min

Safety timer status and duration



CAPACITY CUT-OFF	
ON	1000mAh

Capacity cut-off status and value

Memory Settings

The 1416-C2L can store up to 20 (10 per channel) different charge profiles so that you have easy access to your most commonly used settings.

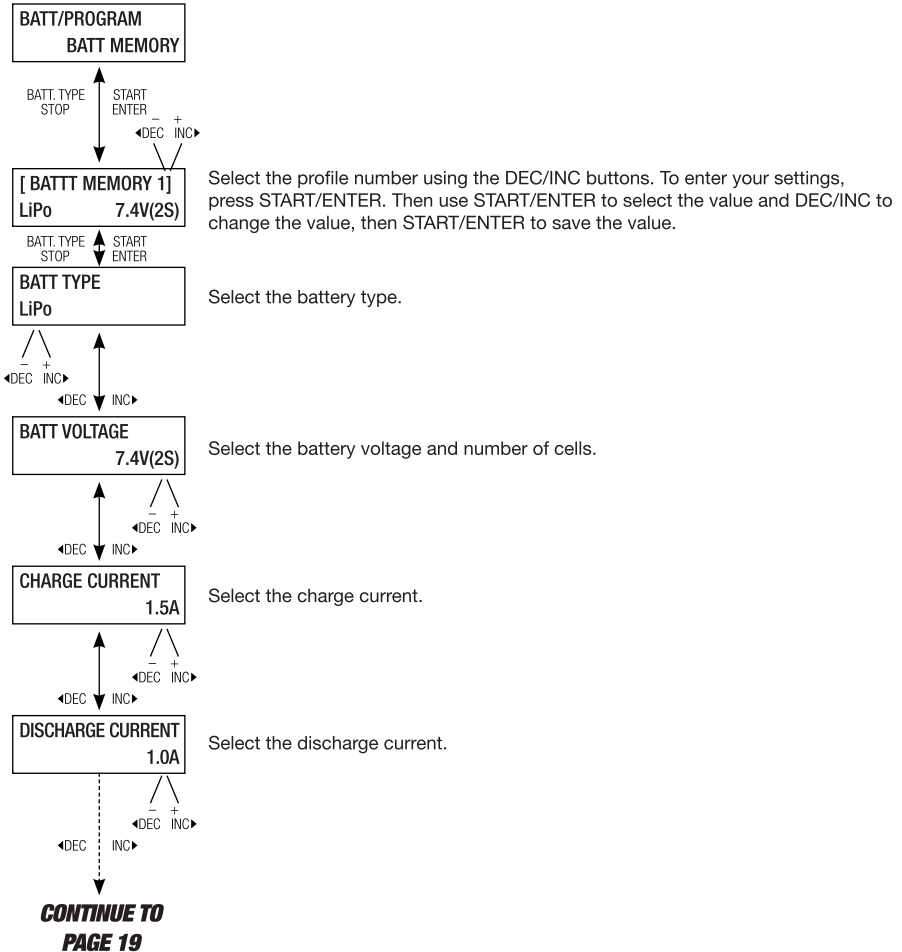

Memory Settings

**CONTINUED FROM
PAGE 18**

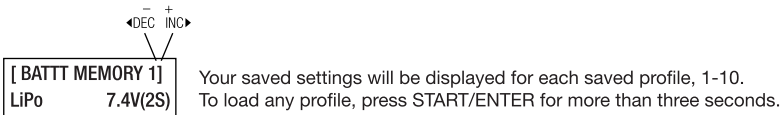
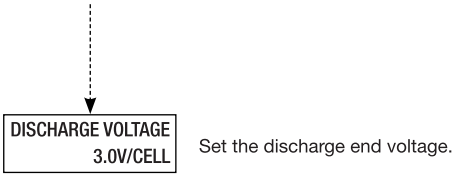

Lithium Battery Meter

Lithium Battery Meter

You can check a battery's total voltage, the voltage of each individual cell, and the voltage of the highest and lowest cell. The battery must be connected to the charger and the balance board to view the readings.

BATT/PROGRAM
BATT METER

From the BATT METER screen, press START/ENTER to enter the program.

BATT. TYPE
STOP

↑ START
↓ ENTER

4.14	4.14	0.00 V
0.00	0.00	0.00 V

The voltage of each cell will be displayed.

◀DEC ↑ INC▶

MAIN:	8.29V
H:4.147	L:4.142V

The total voltage of the battery and the voltage of the highest and lowest cells will be displayed.

Resistance Meter

To help determine the health and performance of your battery, you can check the resistance of each individual cell as well as the total resistance of the battery. The battery must be connected to the charger and the balance board to view the readings.

BATT/PROGRAM
BATT RESISTANCE

Press START/ENTER from the BATT RESISTANCE program screen to begin the testing process.

BATT. TYPE
STOP

↑ START
↓ ENTER

1.7	1.7	0.0 mΩ
0.0	0.0	0.0 mΩ

After 5 seconds, the resistance values of each cell will be displayed.

◀DEC ↑ INC▶

TOTAL:	3.4MΩ
--------	-------

The overall resistance of the battery will be calculated and displayed.

DC Power Supply

Each channel of your 1416-C2L can be used as a DC power supply to power a pit light, tire sander, battery warmer or other pit accessories.

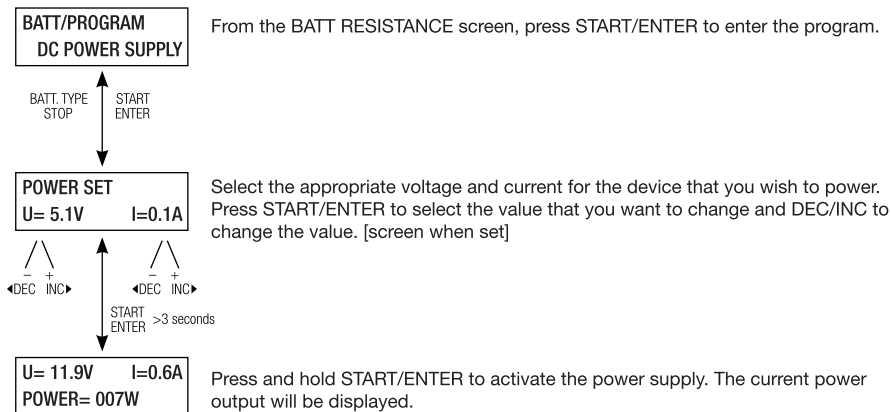

Warning and Error Messages

REVERSE POLARITY

REVERSE POLARITY - Incorrect polarity detected.

CONNECTION BREAK

CONNECTION BREAK - The battery has been disconnected from the charger during the charging/discharging process.

CONNECT ERROR CHECK MAIN PORT

CONNECT ERROR CHECK MAIN PORT - The battery is not connected correctly.

DC IN TOO LOW

DC IN TOO LOW - The DC input voltage is less than 11V.

DC IN TOO HIGH

DC IN TOO HIGH - The DC input voltage is greater than 18V.

CELL ERROR LOW VOLTAGE

CELL ERROR LOW VOLTAGE - The voltage of one or more cells in the battery pack is too low.

CELL ERROR HIGH VOLTAGE

CELL ERROR HIGH VOLTAGE - The voltage of one or more cells in the battery pack is too high.

CELL ERROR VOLTAGE- INVALID

CELL ERROR VOLTAGE-INVALID - The voltage of one or more cells is undetectable.

INT. TEMP TOO HIGH

INT. TEMP. TOO HIGH - The internal temperature of the charger is too high.

OVER CHARGE CAPACITY LIMIT

OVER CHARGE CAPACITY LIMIT - The battery's capacity has reached the maximum capacity set by the user.

OVER TIME LIMIT

OVER TIME LIMIT - The charging time has surpassed the maximum charging time set by the user.

BATTERY FULL

BATTERY FULL - The charger detects that the battery is already charged to maximum capacity.

Warranty

Your Reedy 1416-C2L Dual AC/DC Competition Battery Charger is warranted to the original purchaser for 90 days from the date of purchase, verified by the sales receipt, against defects in material and workmanship. Product that has been mishandled, abused, used incorrectly, used for an application other than intended, or damaged by the user are not covered under warranty. Associated Electrics Inc. is not liable for any loss or damage, whether direct or indirect, incidental or consequential, or from any special situation, arising from the use, misuse, or abuse of this product.

Regulatory Information

Reedy Power 1416-C2L complies with all relevant and mandatory EC directives and FCC Part 15 Subpart B.

Test Standards	Title	Result
EN 55014-1:2017 Electromagnetic compatibility	Requirements for Household Appliances, electric tools, and similar apparatus –Part 1: Emission	Conform
EN 55014-2:2015 Electromagnetic compatibility	Requirements for Household Appliances, electric tools, and similar apparatus – Part 2: Immunity- Product family standard	Conform
EN 61000-3-2:2014 Electromagnetic compatibility (EMC)	Part 3-2: Limits-Limits for harmonic current emissions (equipment input current up to and including 16 A per phase	Conform
EN 61000-3-3:2013 Electromagnetic compatibility (EMC)	Part 3-3: Limits - Limitation of voltage changes, voltage fluctuations and flicker in public low-voltage supply systems, for equipment with rated current \leq 16 A per phase and not subject to conditional connection	Conform
EN 60335-2-29:2004+A2:2010+ A11:2018 to be used in conjunction with EN 60335-1:2012+A11:2014+ A13:2017	Safety of household and similar electrical appliances	Conform
FCC Rules Part 15 Subpart B	Unintentional Radiators	Conform



The crossed-out wheeled bin means that within the European Union, this product must be taken to a separate waste collection facility at the product's end of life. Do not dispose of this product as unsorted municipal waste.

FCC Note:

This device complies with Part 15 of the FCC rules. Operation is subject to the following two conditions:

(1) this device may not cause harmful interference, and (2) this device must accept any interference received, including interference that may cause undesired operation. The manufacturer is not responsible for any radio or TV interference caused by unauthorized modifications or change to this equipment. Such modifications or change could void the user's authority to operate the equipment.

This equipment has been tested and found to comply with the limits for a Class B digital device, pursuant to part 15 of the FCC Rules. These limits are designed to provide reasonable protection against harmful interference in a residential installation. This equipment generates, uses and can radiate radio frequency energy and, if not installed and used in accordance with the instructions, may cause harmful interference to radio communications. However, there is no guarantee that interference will not occur in a particular installation. If this equipment does cause harmful interference to radio or television reception, which can be determined by turning the equipment off and on, the user is encouraged to try to correct the interference by one or more of the following measures:

- Reorient or relocate the receiving antenna.
- Increase the separation between the equipment and receiver.
- Connect the equipment into an outlet on a circuit different from that to which the receiver is connected.
- Consult the dealer or an experienced radio/TV technician for help. To maintain compliance with FCC's RF exposure guidelines, this equipment should be installed and operated with a minimum distance of 20cm between the radiator and your body.15 Subpart B.



21062 Bake Parkway Lake Forest, CA 92630 USA

call: (949) 544-7500 - fax: (949) 544-7501

visit us at: www.ReedyPower.com

for all of our current products, new releases, setup help, tips, and racing info!

FOLLOW US ON SOCIAL MEDIA



TeamAssociated
ReedyPower
ElementRC



@TeamAssociatedRC
@ReedyPower
@Element RC



@Team_Associated
@ReedyPower



AFactoryTeam



Made in China